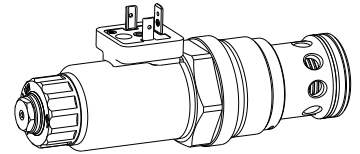

**Proportional pressure relief valve
Screw-in cartridge**

- Pilot operated
- $Q_{max} = 400 \text{ l/min}$
- $p_{max} = 400 \text{ bar}$
- $p_{Nmax} = 350 \text{ bar}$

M42x2
 ISO 7789

DESCRIPTION

Pilot operated, proportional pressure relief valve, as screw-in cartridge with a thread M42x2 for cavity according to ISO 7789. 4 standard pressure levels are available: 100 bar, 200 bar, 275 bar and 350 bar. The adjustment takes place by means of a Wandfluh proportional solenoid (VDE-standard 0580). The cartridge body made of steel is zinc coated and therefore rust-protected. The solenoid coil is zinc-/nickel-coated.

FUNCTION

When the operating pressure set by the proportional solenoid is reached, the main spool opens and connects the protected line with the return line to the tank. The back pressure in T influences the pressure in P (1). This pilot operated proportional pressure relief valve can be adjusted very sensitively and is suitable for large volume flows and high pressures. To control the valve, Wandfluh proportional amplifiers are available (see register 1.13).

APPLICATION

The valve has its application in hydraulic systems, in which the pressure frequently has to be changed. The facility for electric remote controlling of the valve in conjunction with process control systems enables economic problem solutions with repeatable sequences.

TYPE CODE

		B V P PM42 - <input type="checkbox"/> - <input type="checkbox"/> / <input type="checkbox"/> - <input type="checkbox"/> <input type="checkbox"/> <input type="checkbox"/> # <input type="checkbox"/>									
Pressure relief valve											
Pilot operated											
Proportional											
Screw-in cartridge M42x2											
Nominal pressure range p_N	100 bar <input type="checkbox"/> 100 200 bar <input type="checkbox"/> 200 275 bar <input type="checkbox"/> 275 350 bar <input type="checkbox"/> 350										
Nominal voltage U_N	12 VDC <input type="checkbox"/> G12 24 VDC <input type="checkbox"/> G24 without coil <input type="checkbox"/> X5										
Slip-on coil	Metal housing, round <input type="checkbox"/> W Metal housing, square <input type="checkbox"/> M*										
Connection execution	Connector socket EN 175301-803 / ISO 4400 <input type="checkbox"/> D Connector socket AMP Junior-Timer <input type="checkbox"/> J Connector Deutsch DT04-2P <input type="checkbox"/> G										
Sealing material	NBR <input type="checkbox"/> FKM (Viton) <input type="checkbox"/> D1										
Manual override	Armature tube closed (standard) <input type="checkbox"/> Screwed sealing plug <input type="checkbox"/> HB0 Manual emergency actuation <input type="checkbox"/> HB4.5										
Design-Index (Subject to change)											

- Only available in conjunction with other nominal voltages and connection versions. (See data sheet 1.1-174)

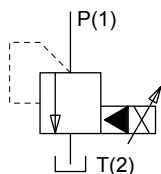
SYMBOLS

GENERAL SPECIFICATIONS

Description	Pilot operated pressure relief valve
Construction	Screw-in cartridge for cavity acc. to ISO 7789
Actuation	Proportional solenoid
Mounting	Screw-in thread M42x2
Ambient temperature	-20...+70 °C
Mounting position	any, preferably horizontal
Fastening torque	$M_D = 100 \text{ Nm}$ for screw-in cartridge $M_D = 5 \text{ Nm}$ for knurled nut
Weight	$m = 0,9 \text{ kg}$

ELECTRICAL SPECIFICATIONS

Construction	Proportional solenoid, wet pin push type, pressure tight	
Standard nominal voltage	$U_N = 12$ VDC	$U_N = 24$ VDC
	$I_G = 1320$ mA	$I_G = 660$ mA
Limiting current		
Relative duty factor	100% ED/DF (see data sheet 1.1-430)	
Protection class acc. to EN 60529	Connection version D: IP 65 J: IP 66 G: IP 67 and 69K	
Other electrical specifications see data sheet 1.1-173 (W) 1.1-174 (M)		

HYDRAULIC SPECIFICATIONS

Fluid	Mineral oil, other fluid on request
Contamination efficiency	ISO 4406: 1999, class 18/16/13 (Required filtration grade $\beta_{6...10} \geq 75$) see data sheet 1.0-50/2
Viscosity range	12 mm ² /s...320 mm ² /s
Fluid temperature	-20...+70 °C
Peak pressure	$p_{max} = 400$ bar $p_{Tmax} = p_p + 15$ bar
Nominal pressure ranges	$p_N = 100$ bar, 200 bar, 275 bar, 350 bar
Volume flow	$Q = 5...400$ l/min
Leakage volume flow	see characteristics
Repeatability	$\leq 2\%$ *
Hysteresis	$\leq 5\%$ *
	* at optimal dither signal

CHARACTERISTICS Oil viscosity $\nu = 30$ mm²/s

$p = f(Q)$ Pressure volume flow characteristics
(Maximal adjustable pressure)

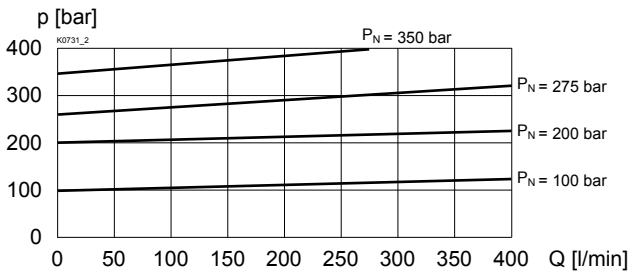

$p = f(Q)$ Pressure volume flow characteristics
(Minimal adjustable pressure)

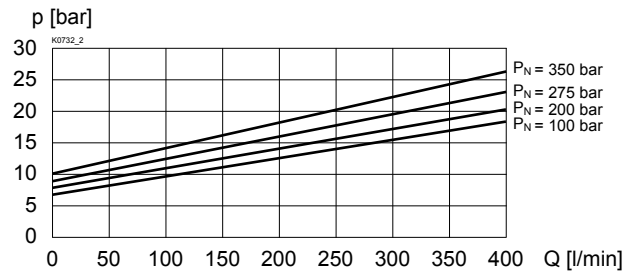

$p = f(I)$ Pressure adjustment characteristics
[at $Q = 30$ l/min (static)]

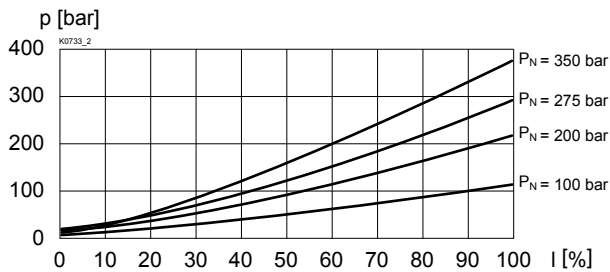

$Q_L = f(p)$ Leakage volume flow characteristics

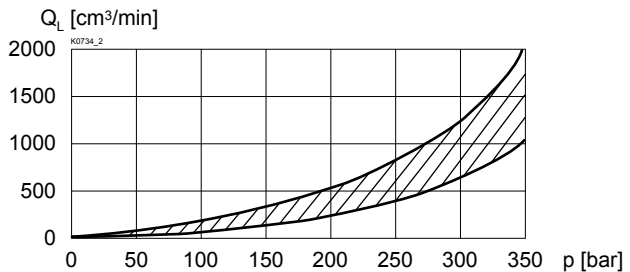

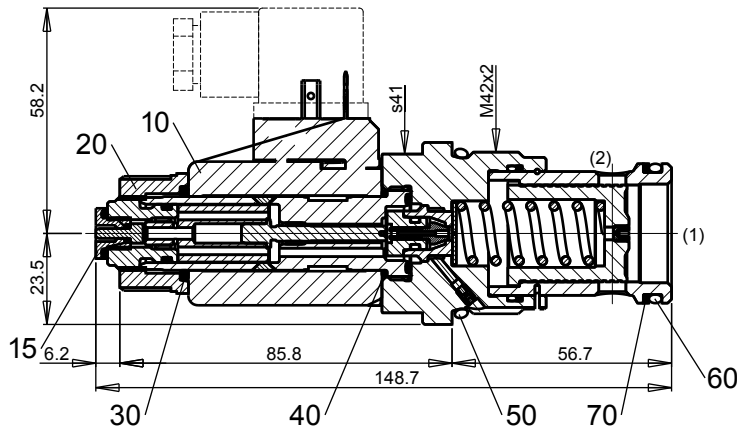
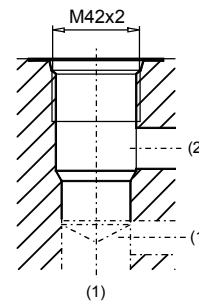
DIMENSIONS / SECTIONAL DRAWING

 Cavity drawing acc. to
 ISO 7789-42-02-0-07

 For detailed cavity drawing
 and cavity tools
 see data sheet 2.13-1048

Dimensions of the other connection versions see data sheet 1.1-173

PARTS LISTE

Position	Article	Description
10	206.2201	EN 175301 Solenoid coil WDS37/19x50-G24
	206.2200	Solenoid coil WDS37/19x50-G12 Junior-Timer
	206.2203	Solenoid coil WJS37/19x50-G24
	206.2202	Solenoid coil WJS37/19x50-G12
	206.2205	Deutsch Solenoid coil WGS37/19x50-G24
	206.2204	Solenoid coil WGS37/19x50-G12
15	253.8000	HB 4,5 Manual override (data sheet 1.1-300)
	239.2033	HB 0 Plug screw (data sheet 1.1-300)
20	154.2700	Knurled nut
30	160.6187	O-ring ID 18,72x2,62 (FKM)
40	160.6172	O-ring ID 17,17x1,78 (FKM)
50	160.2377	O-ring ID 37,77x2,62 (NBR)
	160.8378	O-ring ID 37,77x2,62 (FKM)
60	160.2314	O-ring ID 31,42x2,62 (NBR)
	160.6315	O-ring ID 31,42x2,62 (FKM)
70	049.3364	Backup ring RD 31,5x36x1,4

ACCESSORIES

Line mount body	Data sheet 2.9-200
Proportional amplifier	register 1.13
Mating connector EN 175301-803	Article no. 219.2002

Technical explanation see data sheet 1.0-100