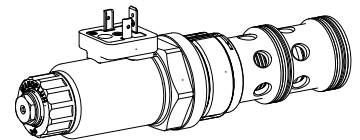

**Proportional pressure reducing valve
 Screw-in cartridge**

- Pilot operated
- $Q_{max} = 250 \text{ l/min}$
- $p_{max} = 400 \text{ bar}$
- $p_{N \text{ red max}} = 350 \text{ bar}$

M42 x 2
 ISO 7789

DESCRIPTION

Pilot operated proportional pressure reducing valve as a screw-in cartridge with a thread M42 x 2 for cavity according to ISO 7789. Four standard pressure levels are available. The adjustment takes place by means of a Wandfluh proportional solenoid (VDE-standard 0580). The cartridge body made of steel is zinc coated and therefore rust-protected. The solenoid coil is zinc-/nickel-coated.

FUNCTION

The proportional pressure reducing valve controls the pressure in port A (1). Proportionally to the solenoid current solenoid force and pressure in port A (1) rise. The valve functions practically independently of pressure in port P (2). A pressure rise in Port A (1) above the set pressure, e.g. due to an active oil consumer, will be prevented by relieving excess volume flow to tank via port T (3). With deneergised solenoid the volume flow passes freely from port P to the consumer port A. Thereby, because of the system, a minimum adjustable pressure in accordance with the characteristic curve cannot be fallen short of. To control the valve, proportional amplifiers are available from Wandfluh (see register 1.13).

APPLICATION

The valve has its application in hydraulic systems, in which the pressure frequently has to be changed. The facility for electric remote controlling of the valve in conjunction with process control systems enables economic problem solutions with repeatable sequences. Installation of the screw-in cartridge in control blocks.

TYPE CODE

Pressure reducing valve			M	V	P	PM42	-		-		/			-			#	
Pilot operated																		
Proportional																		
Screw-in cartridge M42x2																		
Nominal pressure range $p_{N \text{ red}}$	100 bar	<input type="text" value="100"/>																
	200 bar	<input type="text" value="200"/>																
	275 bar	<input type="text" value="275"/>																
	350 bar	<input type="text" value="350"/>																
Standard nominal voltage U_N	12 VDC	<input type="text" value="G12"/>																
	24 VDC	<input type="text" value="G24"/>																
	without coil	<input type="text" value="X5"/>																
Slip-on coil	Metal housing, round	<input type="text" value="W"/>																
	Metal housing, square	<input type="text" value="M*"/>																
Connection execution	Connector socket EN 175301-803 / ISO 4400	<input type="text" value="D"/>																
	Connector socket AMP Junior-Timer	<input type="text" value="J"/>																
	Connector Deutsch DT04-2P	<input type="text" value="G"/>																
Sealing material	NBR	<input type="text" value=""/>																
	FKM (Viton)	<input type="text" value="D1"/>																
Manual override	Armature tube closed (standard)	<input type="text" value=""/>																
	Screwed sealing plug	<input type="text" value="HB0"/>																
	Manual emergency actuation	<input type="text" value="HB4.5"/>																
Design-Index (Subject to change)																		

• Only available in conjunction with other nominal voltages and connection versions. (See data sheet 1.1-174)

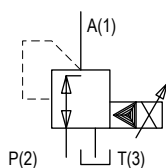
SYMBOLS

GENERAL SPECIFICATIONS

Denomination	Pilot operated proportional pressure reducing valve
Construction	Screw-in cartridge for cavity acc. to ISO 7789
Actuation	Proportional solenoid
Mounting	Screw in thread M42x2
Ambient temperature	-20...70 °C
Mounting position	any, preferably horizontal
Fastening torque	$M_D = 100 \text{ Nm}$ for screw-in cartridge $M_D = 5 \text{ Nm}$ for knurled nut
Weight	$m = 1,05 \text{ kg}$

ELECTRICAL SPECIFICATIONS

Construction	Proportional solenoid, wet pin push type, pressure tight	
Standard nominal voltage	$U_N = 12$ VDC	$U_N = 24$ VDC
	$I_G = 1320$ mA	$I_G = 660$ mA
Limiting current		
Relative duty factor	100% ED/DF (see date sheet 1.1-430)	
Protection class acc. to EN 60529	Connection version D: IP 65 J: IP 66 G: IP 67 and 69K	
Other electrical specifications	see data sheet 1.1-173 (W) 1.1-174 (M)	

HYDRAULIC SPECIFICATIONS

Fluid	Mineral oil, other fluid on request
Contamination efficiency	ISO 4406: 1999, class 18/16/13 (Required filtration grade $\beta_{6...10} \geq 75$) refer to data sheet 1.0-50/2
Viscosity range	12 mm ² /s...320 mm ² /s
Fluid temperature	-20...+70 °C
Peak pressure	$p_{max} = 400$ bar
Nominal pressure range	$P_{N\ red} = 100$ bar, 200 bar, 275 bar, 350 bar
Volume flow range	$Q = 0...250$ l/min
Pilot- and leakage volume flow	see characteristics
Repeatability	$\leq 2\%$ *
Hysteresis	$\leq 5\%$ *
	* at optimal dither signal

CHARACTERISTICS Oil viscosity $\nu = 30$ mm²/s

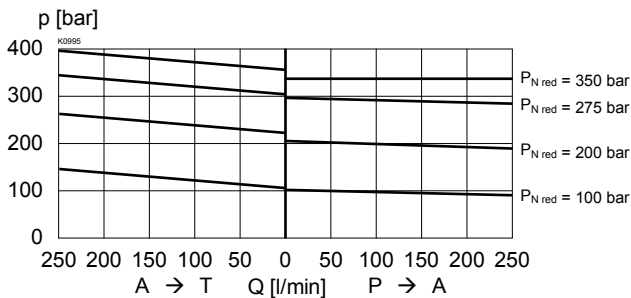
 $p_{red} = f(Q)$ Pressure volume flow characteristics
 (Maximal adjustable pressure)

 $p_{red} = f(Q)$ Pressure volume flow characteristics
 (Minimal adjustable pressure)

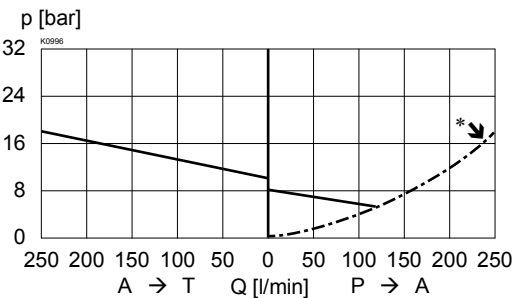
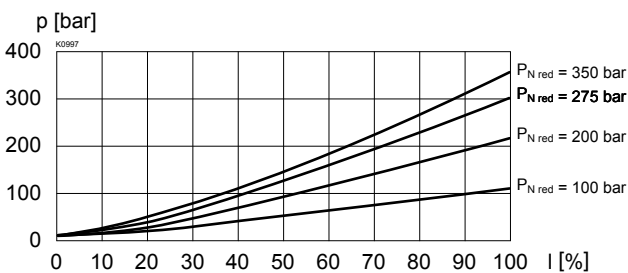
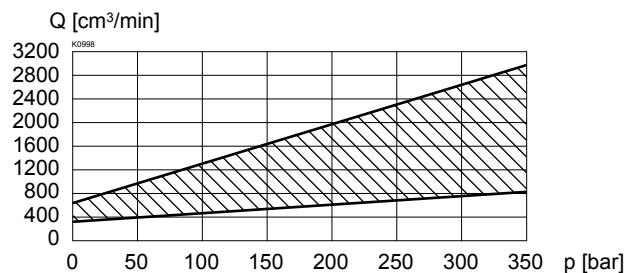
* Consumption resistance dependent on system

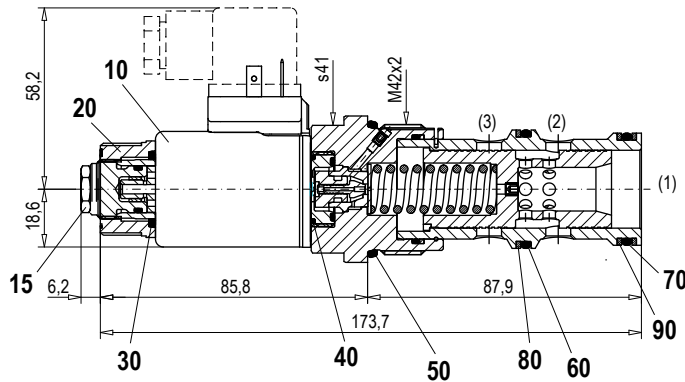
 $p_{red} = f(I)$ Pressure adjustment characteristics
 [at $Q = 0$ l/min (static)]

 $Q_{st+L} = f(p_{red})$ Pilot- and leakage volume flow characteristic [A (1) → T (3)]

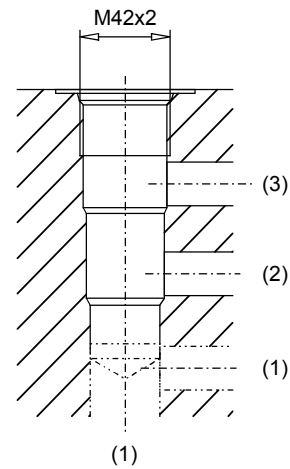
DIMENSIONS / SECTIONAL DRAWINGS

Dimensions of the other connection versions see data sheet 1.1-173

 Cavity drawing acc. to
 ISO 7789-42-04-0-07

 For detailed cavity drawing
 see data sheet 2.13-1047

PARTS LIST

Position	Article	Description
10	206.2201	EN 175301 Solenoid coil WDS37/19x50-G24
	206.2200	Solenoid coil WDS37/19x50-G12
		Junior-Timer
	206.2203	Solenoid coil WJS37/19x50-G24
	206.2202	Solenoid coil WJS37/19x50-G12
		Deutsch
15	206.2205	Solenoid coil WGS37/19x50-G24
	206.2204	Solenoid coil WGS37/19x50-G12
15	253.8000	HB 4,5 override (data sheet 1.1-300)
	239.2033	HB 0 Plug screw (data sheet 1.1-300)
20	154.2700	Knurled nut
30	160.6187	O-ring ID 18,72x2,62 (FKM)
40	160.6172	O-ring ID 17,17x1,78 (FKM)
50	160.2377	O-ring ID 33,77x2,62 (NBR)
	160.8378	O-ring ID 33,77x2,62 (FKM)
60	160.2329	O-ring ID 32,99x2,62 (NBR)
	160.6325	O-ring ID 32,99x2,62 (FKM)
70	160.2314	O-ring ID 31,42x2,62 (NBR)
	160.6315	O-ring ID 31,42x2,62 (FKM)
80	049.3384	Backup ring RD 33,5x38x1,4
90	049.3364	Backup ring RD 33,5x36x1,4

ACCESSORIES

Line mount body	Data sheet 2.9-210
Proportional-Amplifier	register 1.13
Mating connector EN 175301-803	Article no. 219.2002

Technical explanation see data sheet 1.0-100